

PARKER HMI and Visualization Products

Moving to the Next Generation

A Guide to Migrating from the IPX/IPC or EPX2 to the latest IX or PCA

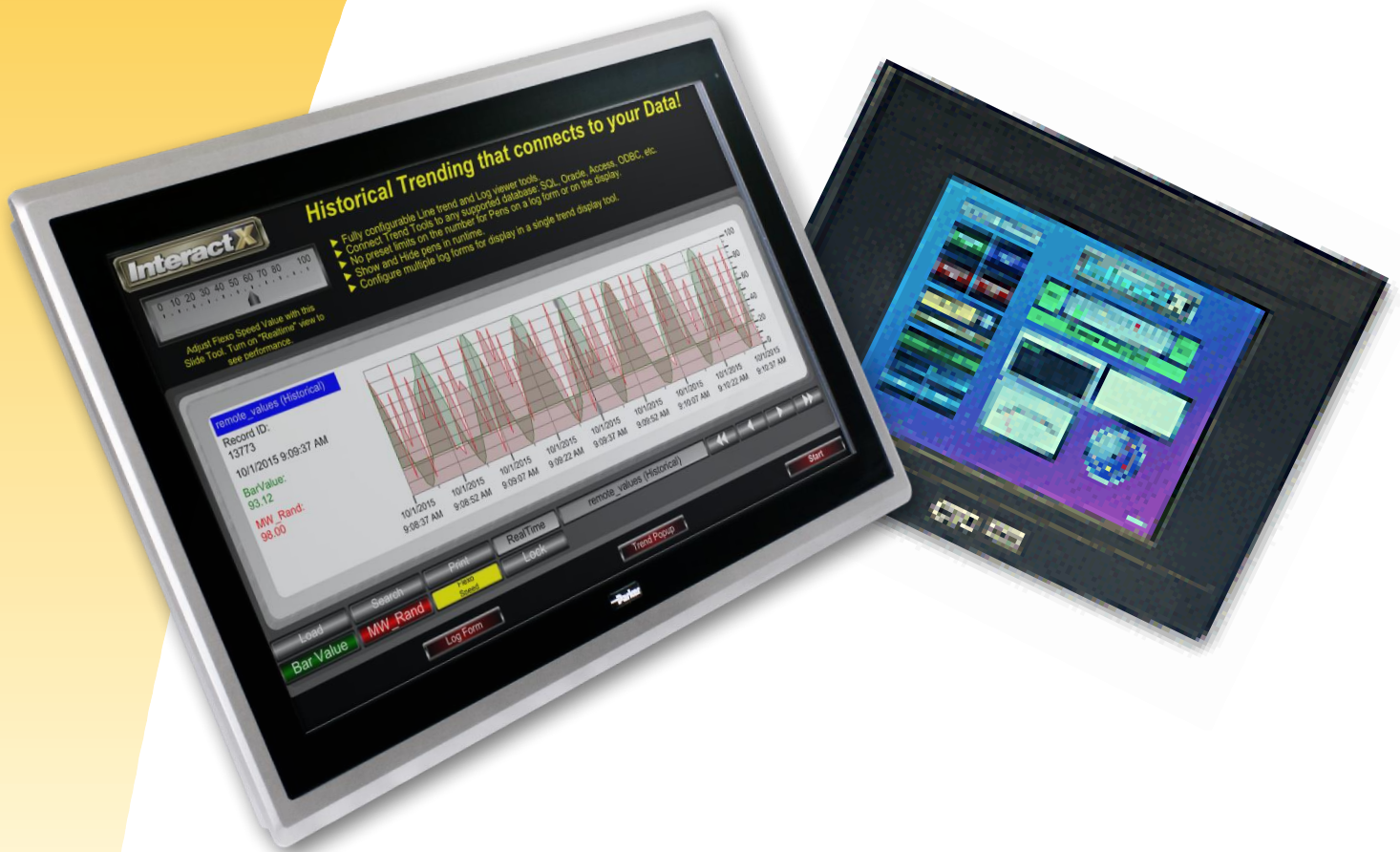

Effective: March 2016

Version 1.0

© 2016 Parker Hannifin Corporation
All Rights Reserved



About this Guide.....	3
Product Overview.....	4
IX versus PCA	4
Product Descriptions	4
Migration and Product Differences	6
Operating System.....	6
Serial Communications	6
Physical Differences	7

About this Guide

This guide is meant to assist users of the IPX, IPC, or EPX2 in upgrading to the latest IX or PCA models. Since this guide only provides an overview of the key differentiating features, it should not be used as the sole documentation when moving from a previous generation IPC, IPC or EPX2 to the new IX or PCA.

This guide should be used in conjunction with each individual products data sheet and user manual. Full links to each products individual product page is provided below where the user can find the aforementioned documentation:

Product	Product Page
IX	bit.ly/Parker_IX
PCA	bit.ly/Parker_PCA
EPX2	bit.ly/ParkerMotion_EPX2
IPX	bit.ly/ParkerMotion_IPX
IPC	bit.ly/ParkerMotion_IPC

If you need any technical assistance or have any questions regarding the best method of migration for your specific application. Feel free to contact us at:

Email: emn_support@parker.com

Phone: 1-800-358-9070

Product Overview

The PCA/IX is not a standard Industrial PC and Windows HMI series; every aspect of their design protects against common failure modes to provide long-lasting and reliable operation and to eliminate machine downtime and maintenance. The IX/PCA's fan-less design allows users to install-and-forget by avoiding the most common component failure in Industrial PCs—the fan. In addition, the IX/PCA's vent-less design helps shield against metal filings and other contaminants from entering the unit, eliminating any need to internally dust or clean the unit.

Often rigidity comes at the sacrifice of looks—this is not the case with the IX's and PCA's sleek cast-aluminum frames. Coupled with a mechanically reinforced SSD and intensive shock and vibration specifications, the IX and PCA are meant to withstand the most intense industrial applications. Yet, their minimal bezels and cabinet depths provide a modern solution that reduces intrusion into the cabinet and minimizes installation area.

Every application running on the IX and PCA is powered with the 1.83 GHz and 4GB DDR3L RAM running an unstripped version of Windows Embedded Standard 7P (WES7P). The IX and PCA can communicate freely with multiple devices using dual-LAN, multiple USB, and traditional serial ports. With configurable RS232/422/485 the IX and PCA does not constrain your communication options.



IX versus PCA

To avoid confusion, it would be helpful to first understand the difference between the IX and PCA. The IX and PCA both use the same hardware and even the same software image. The major difference is that the IX has an additional, internal hardware key that allows the InteractX runtime to operate indefinitely.

Although the PCA also has InteractX pre-installed, it will only run for an hour as a demo. The IX and PCA are often grouped together as IX/PCA when specifications are listed.

This difference also holds true for the previous generation IPX and IPC. The IPC was transformed from an Industrial PC into the IPX, a Windows supervisory HMI, with the installation of the InteractX runtime license. These two are often grouped as IPX/IPC.

Product Descriptions

Industrial PCs	
	<p>PCA – Parker Industrial PC PowerStation - NEW</p> <p>The PCA is the new Industrial PC PowerStation upgraded to meet today's demanding processing needs and harsh industrial environments. With the fan-less vent-less design the Next Generation hardware makes the PCA a low maintenance option that keeps machines running for the long haul. Running an unstripped version of Windows Standard Embedded 7P (WES7P) the PCA is ready to install OEM developed applications and other 3rd party software platforms.</p>
	<p>IPC – Previous Generation – Obsolete</p> <p>The IPC is the precursor to the latest PCA. The IPC, Parker's Industrial PC, provided users with long lasting life with a focus on rugged design. With two processing options, the Celeron or Dual Core, and an extensive sizing choices, the IPC was a popular installation. The PCA continues it's legacy today.</p>





InteractX Windows HMIs	
 	<p>IX – Parker InteractX PowerStation- NEW</p> <p>The IX, based on the same software as the PCA, comes pre-loaded with InteractX Runtime software. InteractX is a powerful supervisory Windows HMI platform packed with OPC client/server capabilities, support for Microsoft Access, SQL, Oracle and ODBC data management. These advanced capabilities are paired with easy to use graphical drag-and-drop development. Screen/tag sharing with Interact Xpress machine level units reduce development time up to 80% when compared with traditional SCADA packages.</p>
	<p>IPX – Previous Generation – Obsolete</p> <p>The IPX—running on the same IPC hardware—offered a powerful platform for InteractX. Running on Windows7 on a SSD, with dual core and 4GB options, the IPX was ahead of its time. It provided peak performance for applications that required significant data collection, database management, and VBA scripting.</p>
	<p>EPX2 – Previous Generation – Mature</p> <p>The EPX2 provided mid-powered alternative to the high-power IPX. The EPX2 brought Parker’s powerful InteractX software to an economical platform. The EPX2 hardware was built to hold up the harshest environments keeping the tradition of Parker’s fan-less and vent-less industrial design.</p>

Table 1 provides a brief summary of specifications meant to highlight the overriding differences between the IX/IPC, EPX2, and IX/PCA.

IPX/IPC - Obsolete	EPX2 – Mature	IX/PCA - NEW
		
2.0 GHz Celeron M 550 2.2 GHz Core2Duo T7500	500 MHz AMD LX800	1.83 GHz Quad Core
80 GB SSD	8 GB Compact Flash	64 GB SSD
2 or 4 GB	512 MB	4 GB
4:3 Display	4:3 Display	16:9 Display
1280 x 1024 Max Resolution	1024 x 768 Max Resolution	1920 x 1080 Max resolution
XP Pro or Windows 7	Windows Embedded 2009	Windows Embedded Standard 7P
100-240 Vac	11-28 Vdc	24 V dc
bit.ly/ParkerMotion_IPX bit.ly/ParkerMotion_IPC	bit.ly/ParkerMotion_EPX2	bit.ly/Parker_IX bit.ly/Parker_PCA

Table 1: Side-by-side specification comparisons between IPX/IPC, EPX2 and the new IX/PCA Series

Migration and Product Differences

Operating System

The IPX/IPC and EXP2 have a variety of operating systems and options. The new IX/PCA default operating system is Windows Embedded Standard 7P (WES7P). The underlying operating system may affect what 3rd party programs and which ActiveX and VBA function calls are supported.

For InteractX users, it is expected that applications that have used the core VBA library functions will be able to seamlessly transfer an InteractX project to WES7P. For any user implementing any 3rd party plug-ins or software should consult with those vendors regarding specific operating system support.

It is important to note that Parker does not remove any functionality from WES7P as other OEMs may do, so it is expect that applications capable of running on Windows 7 will be able to run on the IX or PCA.

Lastly, the new IX/PCA has new default software installed. IPX/IPC and EPX2 has had varying installation defaults, so it's best to compare with your specific application requirements. The following lists the default programs and drivers added onto the WES7P image:

IX/PCA Pre-installed Software List

Windows Standard Embedded 7P	Full—no functionality stripped
InteractX 4.0.0.2137	Runtime license only on IX models
.NET versions 2.0, 3.0, 3.5, 4.0, 4.5.1	
Microsoft SQL Server 2014	
Acronis 2015	
Flash player 19	
Adobe Reader DC version 2015.009.20079	

IX/PCA Pre-installed Drivers

PenMount Resistive touch driver version 2.4.4.345
 eGalax Capacitive Touchscreen driver version 2.4.4.345
 Intel HD Graphics Display driver version 10.18.10.4226

Serial Communications

On both the IPX/IPC and new IX/PCA series, the configurable RS232/422/485 serial ports are defaulted to RS232. To configure the RS232/422/485 port in an IPX/IPC PowerStation, a user would need to change the BIOS settings in the CMOS Set-up menu. To configure the RS232/422/485 selectable port in the IX/PCA it is necessary to both configure a set of DIP switches and change the BIOS settings. The DIP switches are accessible on the IX/PCA by removing the cover plate and SSD card from the back of the unit. The full instructions for configuring the IX COM port are provided in the user manual available bit.ly/Parker_IX and bit.ly/Parker_PCA.

IPX/IPC	EPX2	IX/PCA
COM 1: RS232	COM 1: RS232	COM 1: RS232/422/485
COM 2: RS232/422/485	COM 2: RS232/422/485	COM 2: RS232
COM 3: RS232*		

Table 2: IPX versus IX Serial Port Comparison

*Not all IPX/IPC models were equipped with a COM 3 port. Use your units part number and IPX/IPC user guide and data sheet to determine your models available serial ports.

The IPX/IPC configurable serial port was located on COM2 while the IX/PCA configurable serial port is located on COM1. Users that configured COM2 and utilized it within their InteractX application may need to reprogram their unit to instead reference COM1.

The pin-out for RS232 is identical between the IPX/IPC, EPX2, and IX/PCA series; However, there are differences in the RS422 and RS485 pin-outs shown in the wiring diagrams provided below:

RS422 and RS485 Diagrams

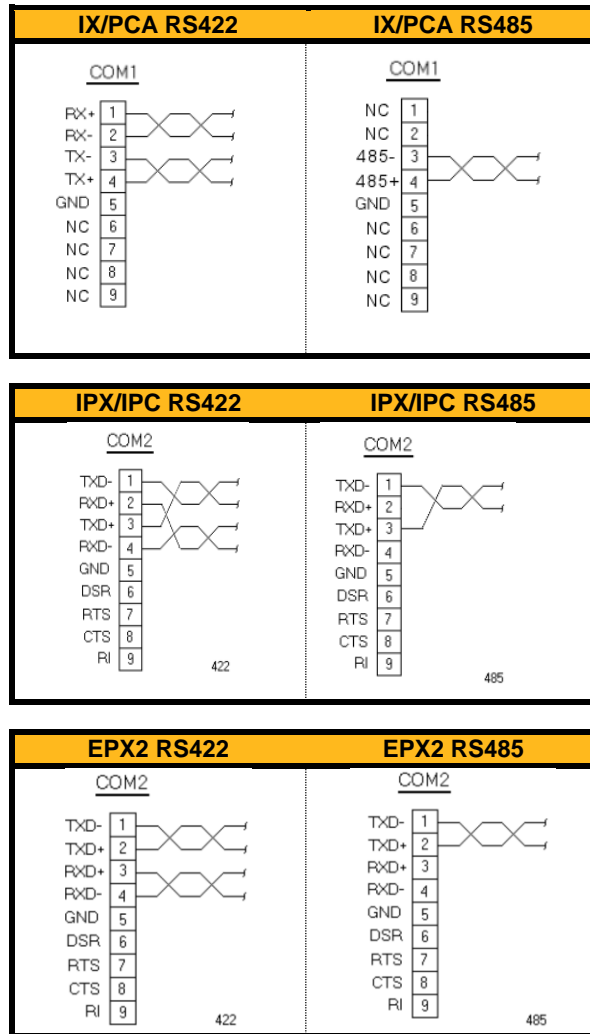

Physical Differences

IPX/IPC Model Size	IPX/IPC Cutout [mm]	IX/PCA Model Size	IX/PCA Cutout [mm]
IPX/IPC00...	--	IX/PCA-000-...	--
10" IPX/IPC10...	252.7 x 320.0	10" IX/PCA-010-...	176.0 x 272.0
15" IPX/IPC15...	315.0 x 403.9	15" IX/PCA-015-...	259.5 x 349.0
17" IPX/IPC17...	362.2 x 433.3	22" IX/PCA-022-...	334.0 x 539.0

Table 3 provides a list of the IPX/IPC and EPX2 models and their closest mechanical size equivalent in the IX/PCA series. The new IX/PCA models do not provide a mechanical drop-in replacement and this table is meant to be used as a product comparison alone. The new IX/PCA 16:9 models provides 40% more

screen space over the previous IPX/IPC and EPX2 4:3 series. In addition, the new IX/PCA series provides additional size ranges not previously available in the IPX/IPC and EPX2.

Some users may chose this opportunity to either increase or decrease the size of their touch screen depending on preference. If the application does not allow flexibility to transition from an IPX 4:3 cutout to the new IX 16:9 cutout, it is recommended that the customer user Parker's new transition plates, described in the next section.

IPX/IPC Model Size	IPX/IPC Cutout [mm]	IX/PCA Model Size	IX/PCA Cutout [mm]
IPX/IPC00...	--	IX/PCA-000-...	--
10" IPX/IPC10...	252.7 x 320.0	10" IX/PCA-010-...	176.0 x 272.0
15" IPX/IPC15...	315.0 x 403.9	15" IX/PCA-015-...	259.5 x 349.0
17" IPX/IPC17...	362.2 x 433.3	22" IX/PCA-022-...	334.0 x 539.0

Table 3: IPX/IPC models and closest mechanical IX/PCA equivalent

EPX2 Model Size	EPX2 Cutout [mm]	IX Model Size	IX Cutout [mm]
EPX200...	--	IXA-000-...	--
6" EPX206	114.3 x 157.5	7" IXA-007-...	136.0 x 192.0
8" EPX208	154.0 x 220.0		
10" EPX210...	252.7 x 320.0	10" IXA-010-...	176.0 x 272.0
15" EPX215...	315.0 x 403.9	15" IXA-015-...	259.5 x 349.0

Table 4: EPX2 models and closest mechanical IX equivalent

Transition Plates

To make the mechanical transition as easy as possible, Parker has developed 4:3 to 16:9 adapter plates for some sizes. These plates require no changes in the users' current IPX/IPC or EPX2 cutout and allow the new IX or PCA series to fit within the same mechanical constraints.

The transition plate system consists of two steel plates. The first steel plate containing the threaded studs, is set within the legacy IPX/IPC and EPX2 cutout on the outside of the customer enclosure. The threaded studs provide the alignment required to ensure proper installation and centering. The second plate is attached to the first from the inside of the enclosure. When compressed with the included lock nuts, the two plates provide a compression force providing a seal and secure hold. The new IX or PCA then mounts into the assembled transition plate system using the same installation process and clamps as if it were mounting into a new standard enclosure cutout.

The outside-facing steel plate is colored ANSI 61 gray to match Hoffman and many other enclosure brands. If a different paint color is required, please contact Parker.

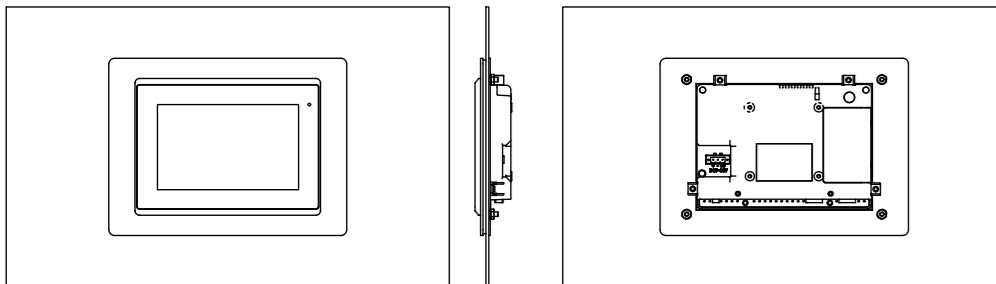

IPX/IPC Size	EPX2 Size	IX/PCA Model	Conversion Plate Part #
10"	10"	IX/PCA-010-...	ADPT-010-600
15"	15"	IX/PCA-015-...	ADPT-015-600